



TRUFIG





TRUFIG

Key Features:

- True flush-mounted aesthetic
- Continuity of color and texture across multiple devices
- Uniform industrial design
- Plastic or metal back boxes available to meet installation or code requirements
- 1/2" or 5/8" mounting platforms available
- Plaster thickness to 3/8"
- ETL - Certified



Applications:

- Drywall (Level 5 / smooth wall finish)
- Plaster (vener to Venetian)
- Additional applications for wood & stone with TRUFIG Solid Surface Solutions

Supported Categories:

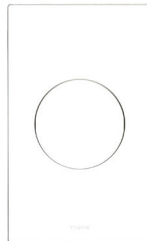

Switches

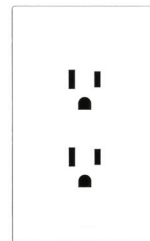

Power Outlets

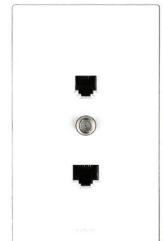

Data Jacks



Keypads

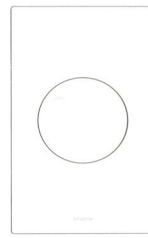

Volume Controls



Touch Panels

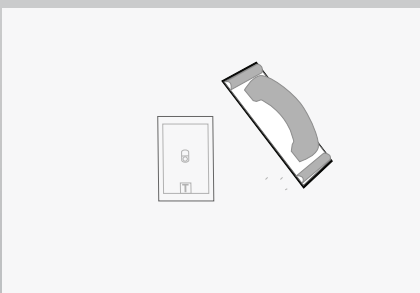
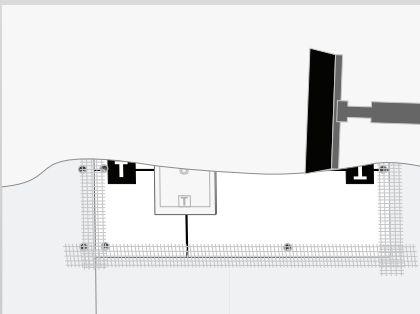
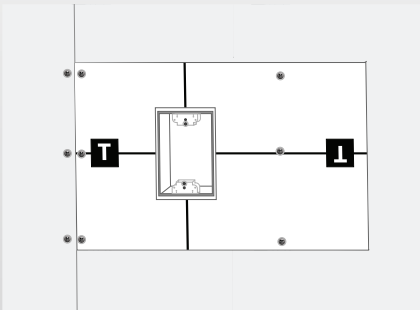
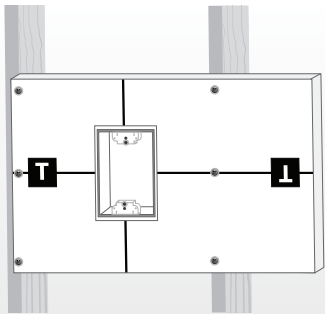
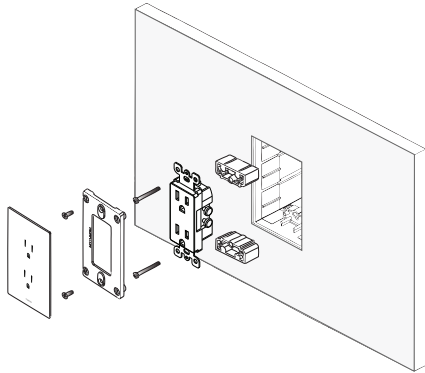

DRYWALL & PLASTER INSTALLATION PROCESS

TRUFIG.COM

Available at:

DSI Entertainment Systems (866) 692-8489
audio video cinema integration

www.dsientertainment.com